



# CO-EXTRUSION ALUMINUM TUBE INSTALLATION GUIDE



Foshan MexyTech Co., Ltd  
[www.mexytech.com](http://www.mexytech.com)

# TOOL PREPARATION

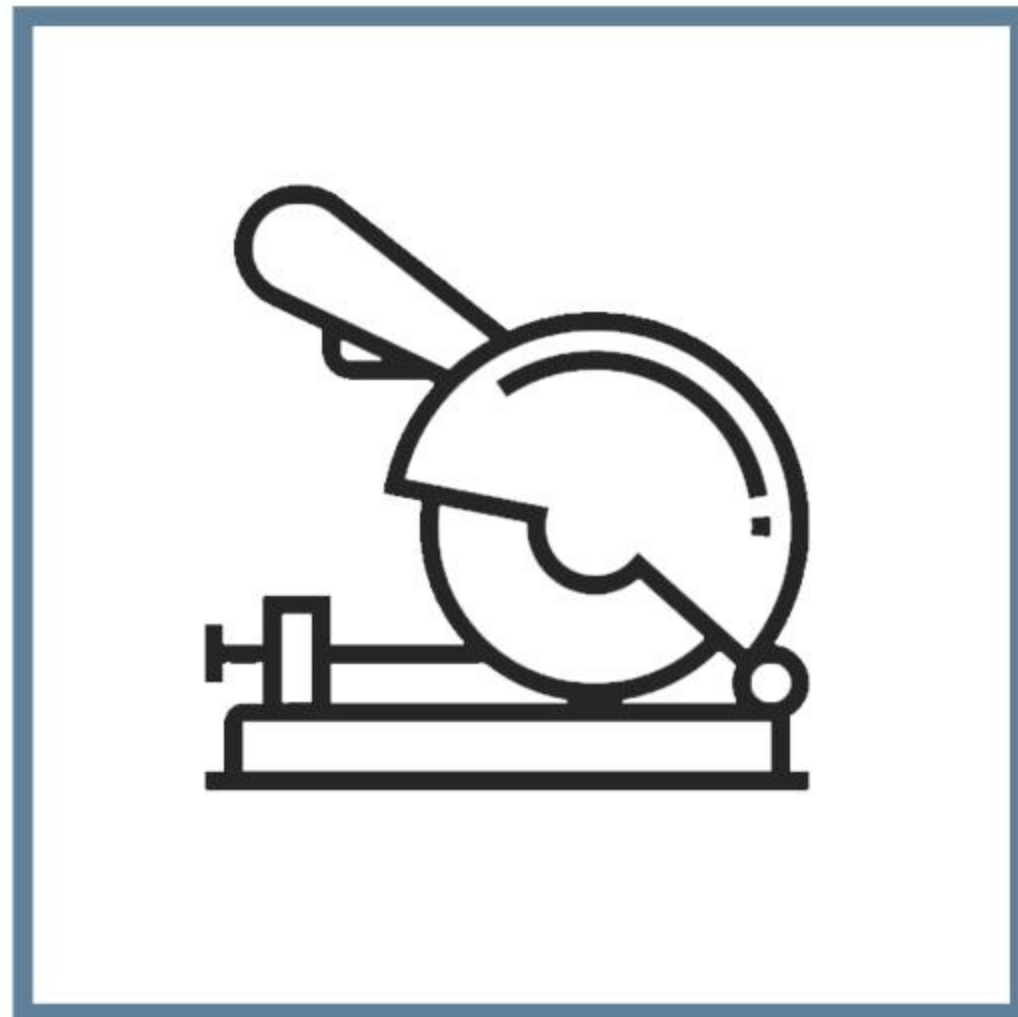

SAW

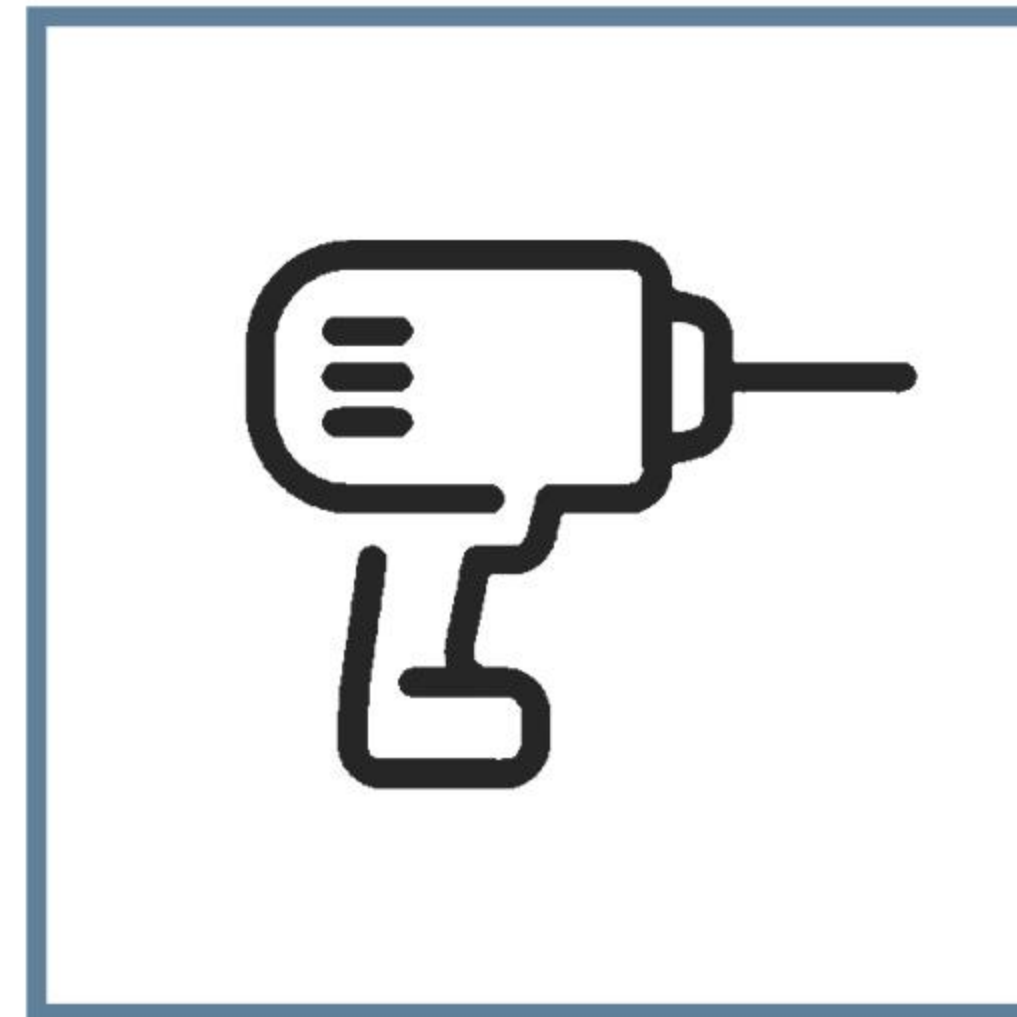

DRILL

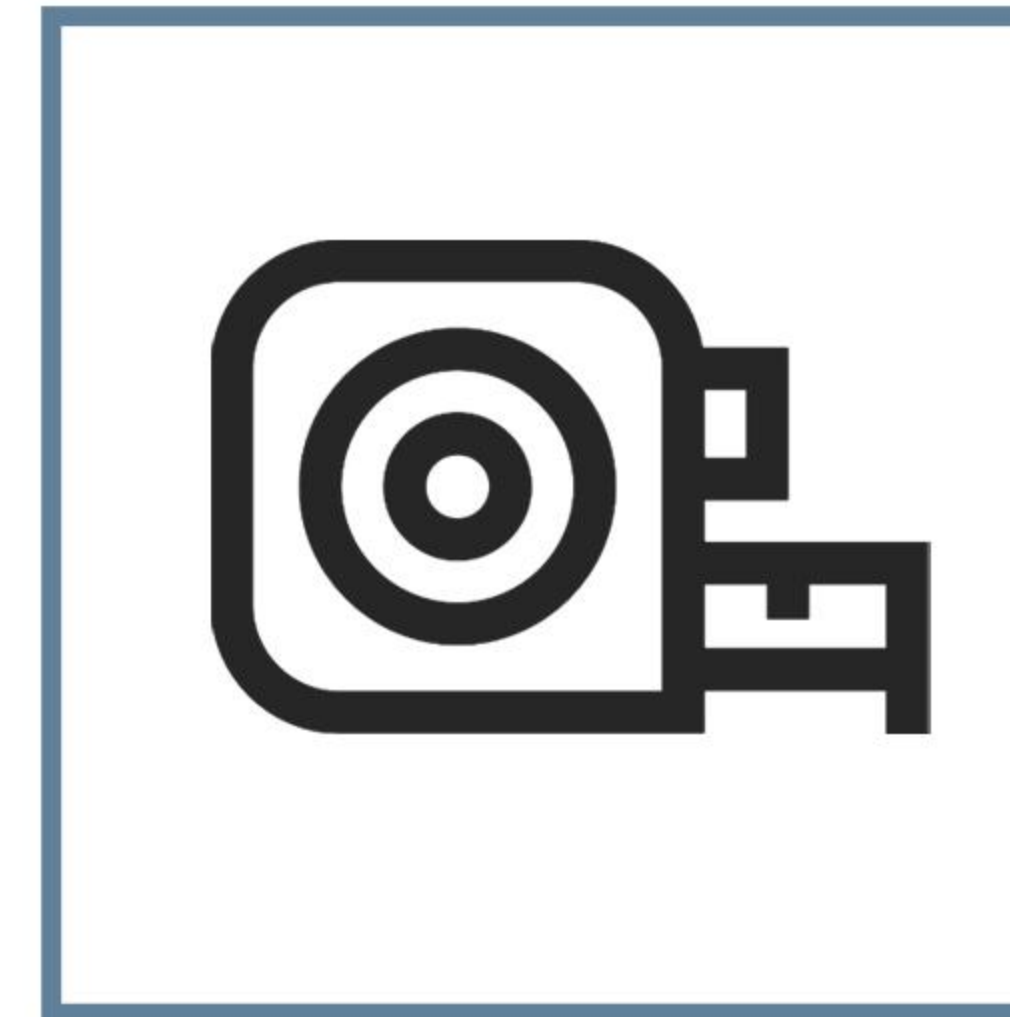

TAPE RULE

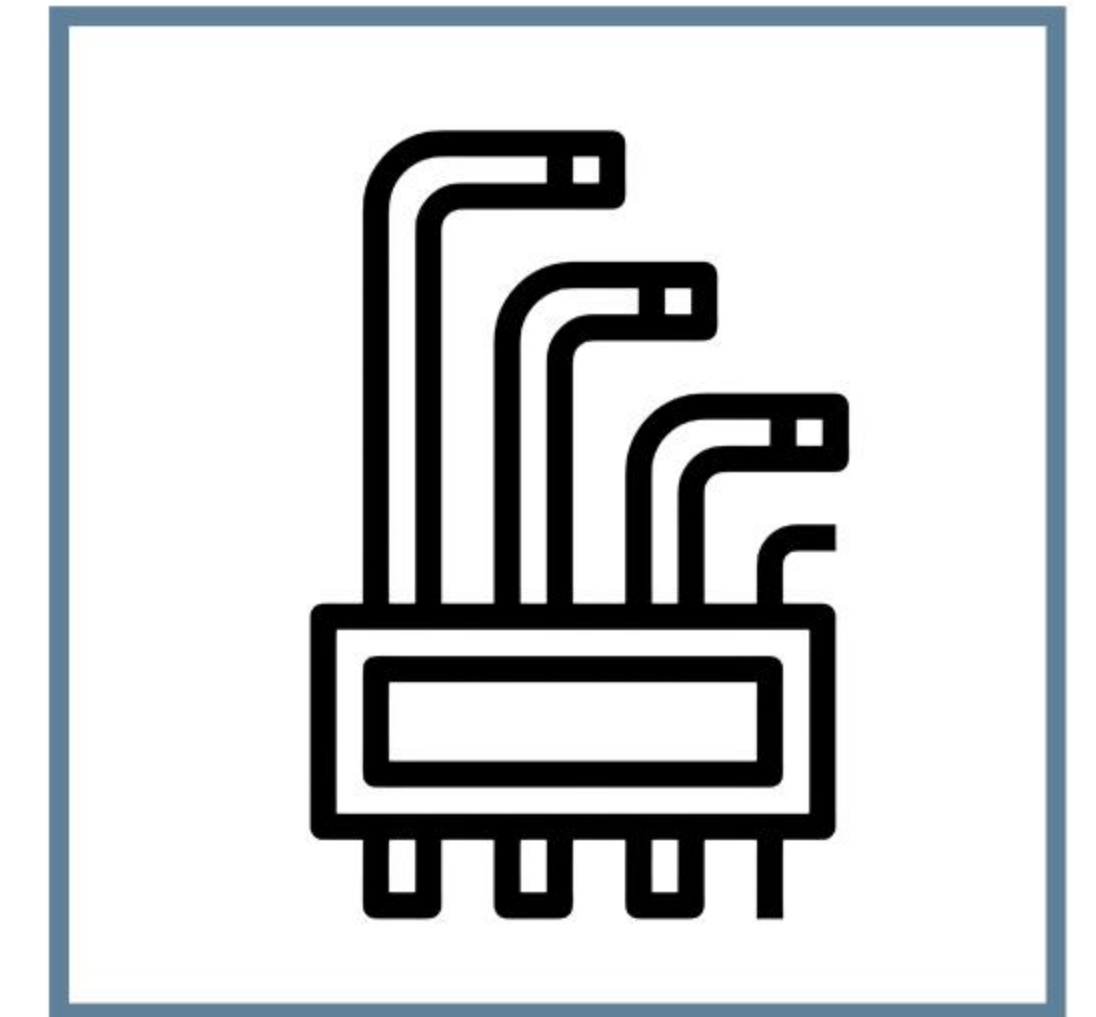

HEXAGONAL WRENCH

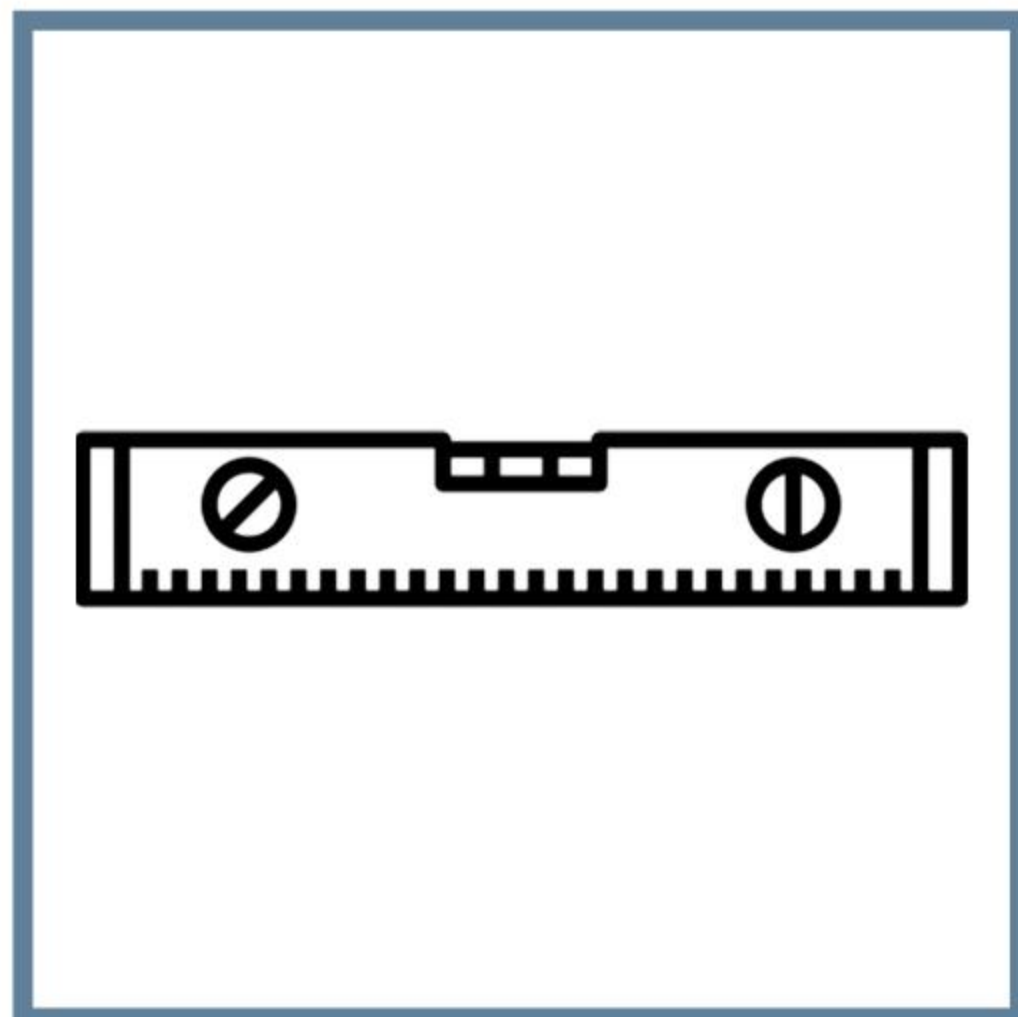

SPIRIT LEVEL

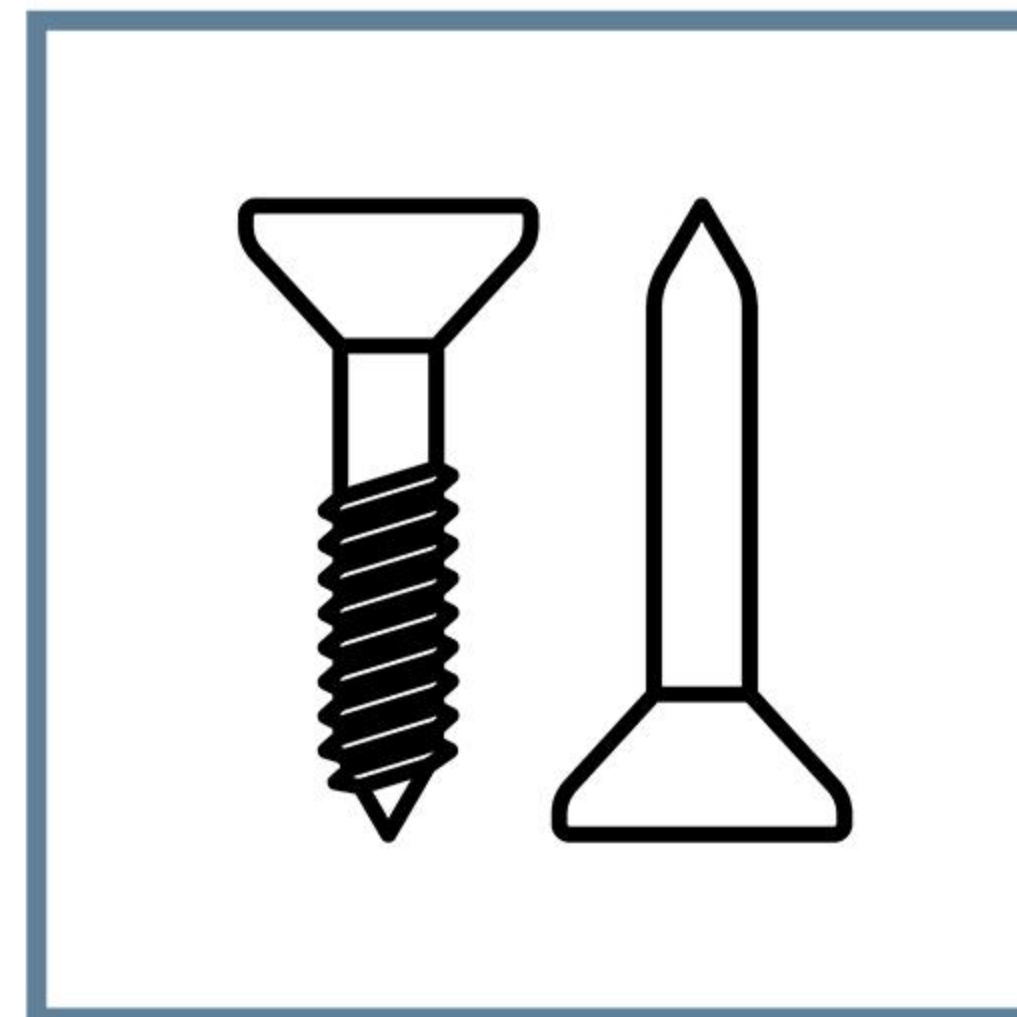

SCREW

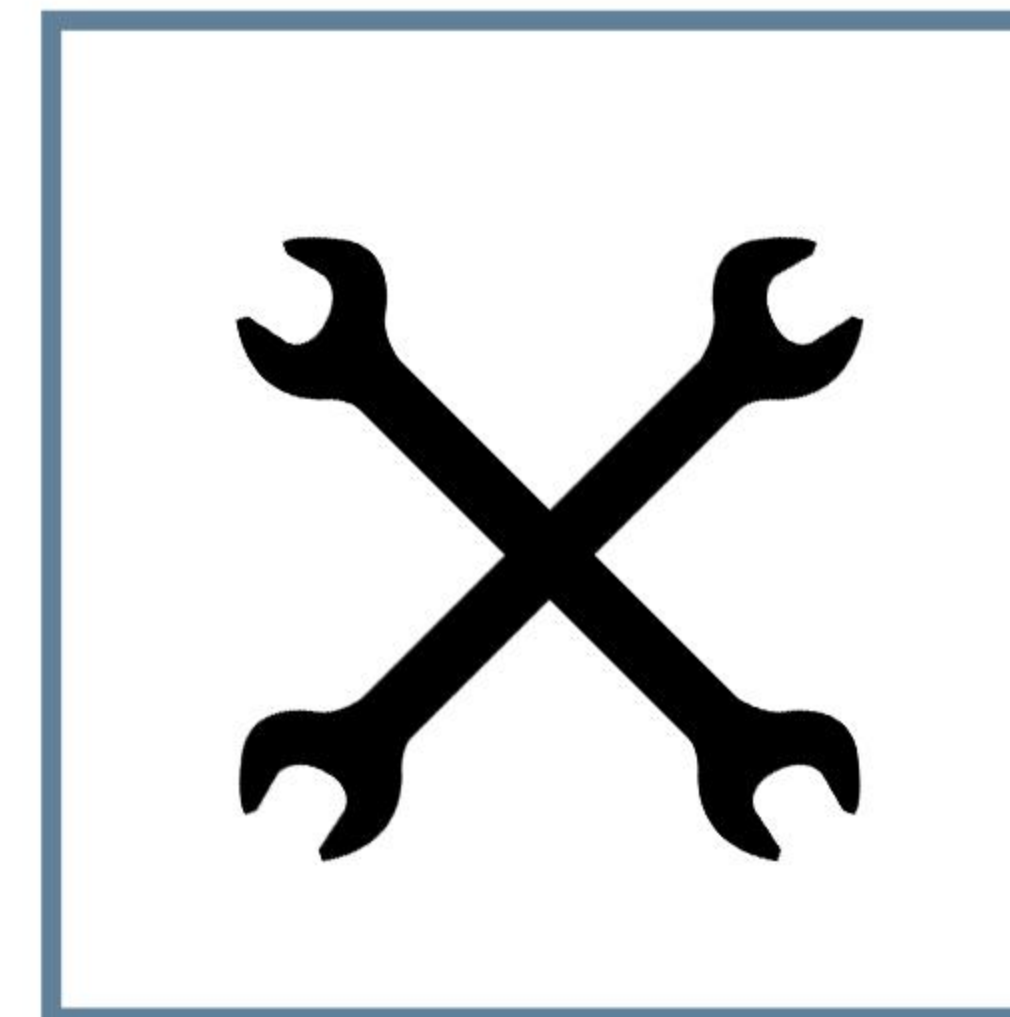

SPANNER



PROTECTION INSTRUMENT

# INSTALLATION MATERIAL



**CO-EXTRUSION  
ALUMINUM TUBE**



**TUBE END COVER**



**L-SHAPE JOIST**



**RIVET BOLT**



**RIVET HEAD**



**M6\*20 SCREW**



**L BRACKET**



**HEXAGON SOCKET  
HEAD SCREWS**



**EXPANSION SCREW**



**ROUND HEAD  
SELF-DRILLING SCREWS**



**SCREW**

## INSTALLATION DISTANCE REFERENCE (TUBE SIDE TO SIDE)

Tube Size	Recommended Tube Distance(Wide Side at the Front)-Distance A	Recommended Tube Distance(Narrow Side at the Front)-Distance B	L Bracket Distance-Distance C	L-shape Joist Distance(Horizontal Installation)-Distance D	L-shape Joist Distance(Vertical Installation)-Distance E
AC-ST01 25x15	25mm	15mm	1.5m	1.5m	1.5m
AC-ST02 50x30	50mm	30mm	1.5m	1.5m	3m
AC-ST03 60x50	60mm	50mm	1.5m	1.5m	3m
AC-ST04 80x40	80mm	40mm	1.5m	2m	3m
AC-ST05 120x30	120mm	30mm	1.5m	2.5m	3m

# INSTALLATION EXAMPLE- TUBE VERTICAL INSTALLATION



Distance A when the wide side at the front

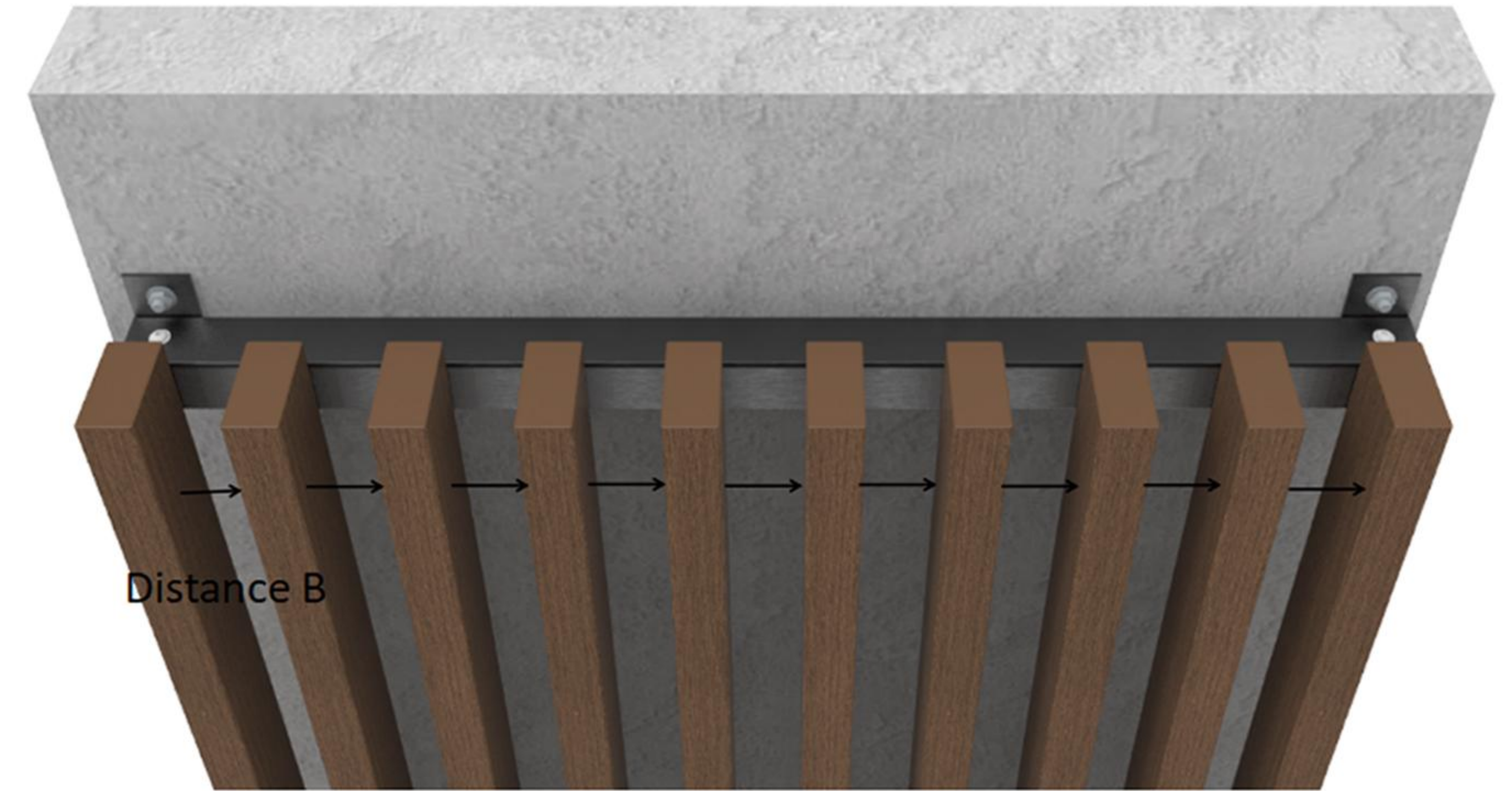

Distance B when the narrow side at the front

## Step 1: Confirm following based on beam size

- a. Installation direction- whether wide/narrow side is at the front and the tube distance accordingly.  
(Please note that the distance refers to side of one tube to side of the other)

# INSTALLATION EXAMPLE- TUBE VERTICAL INSTALLATION

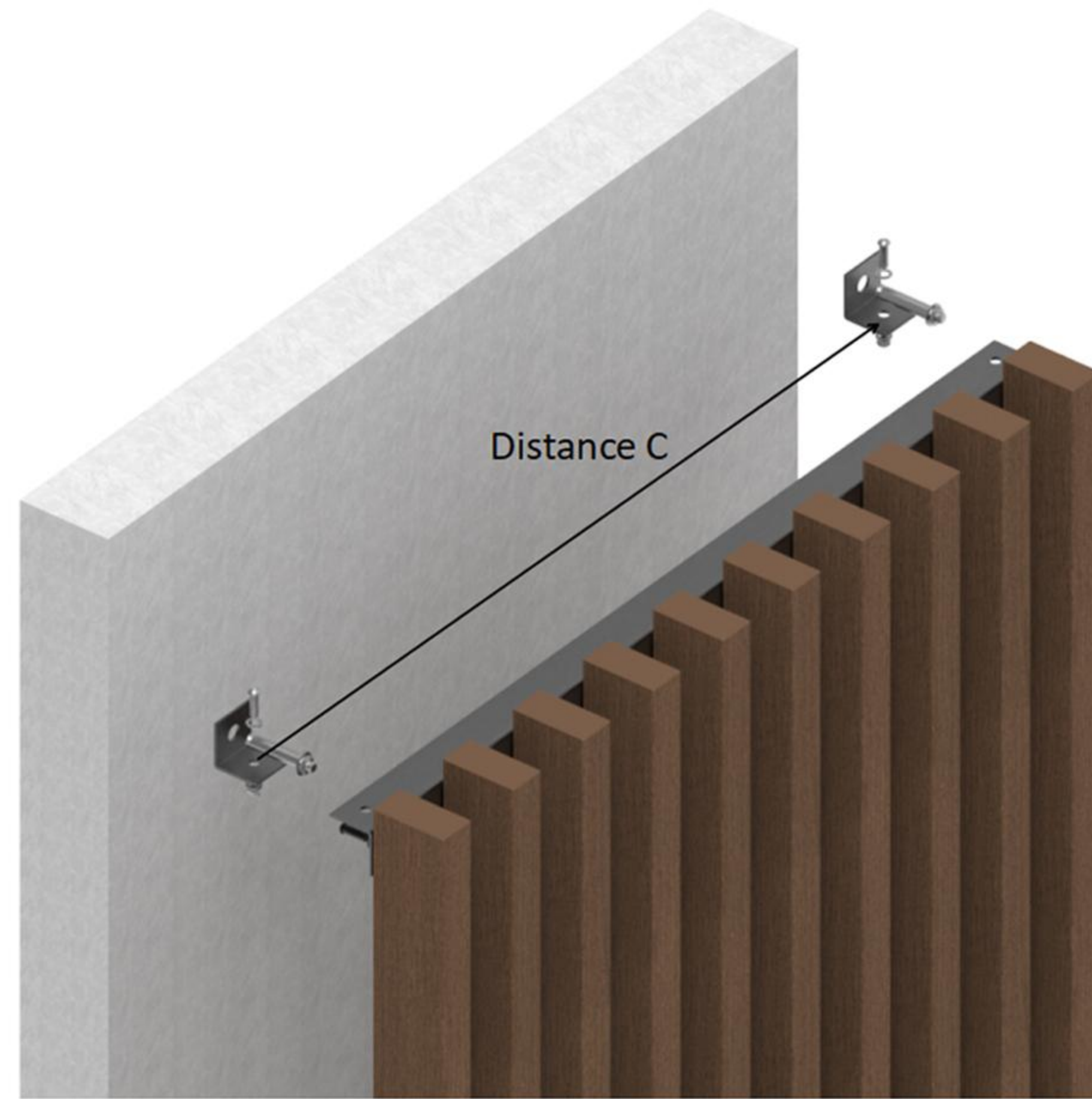

Distance C of L bracket

Hanging length at both ends  
less than 10cm

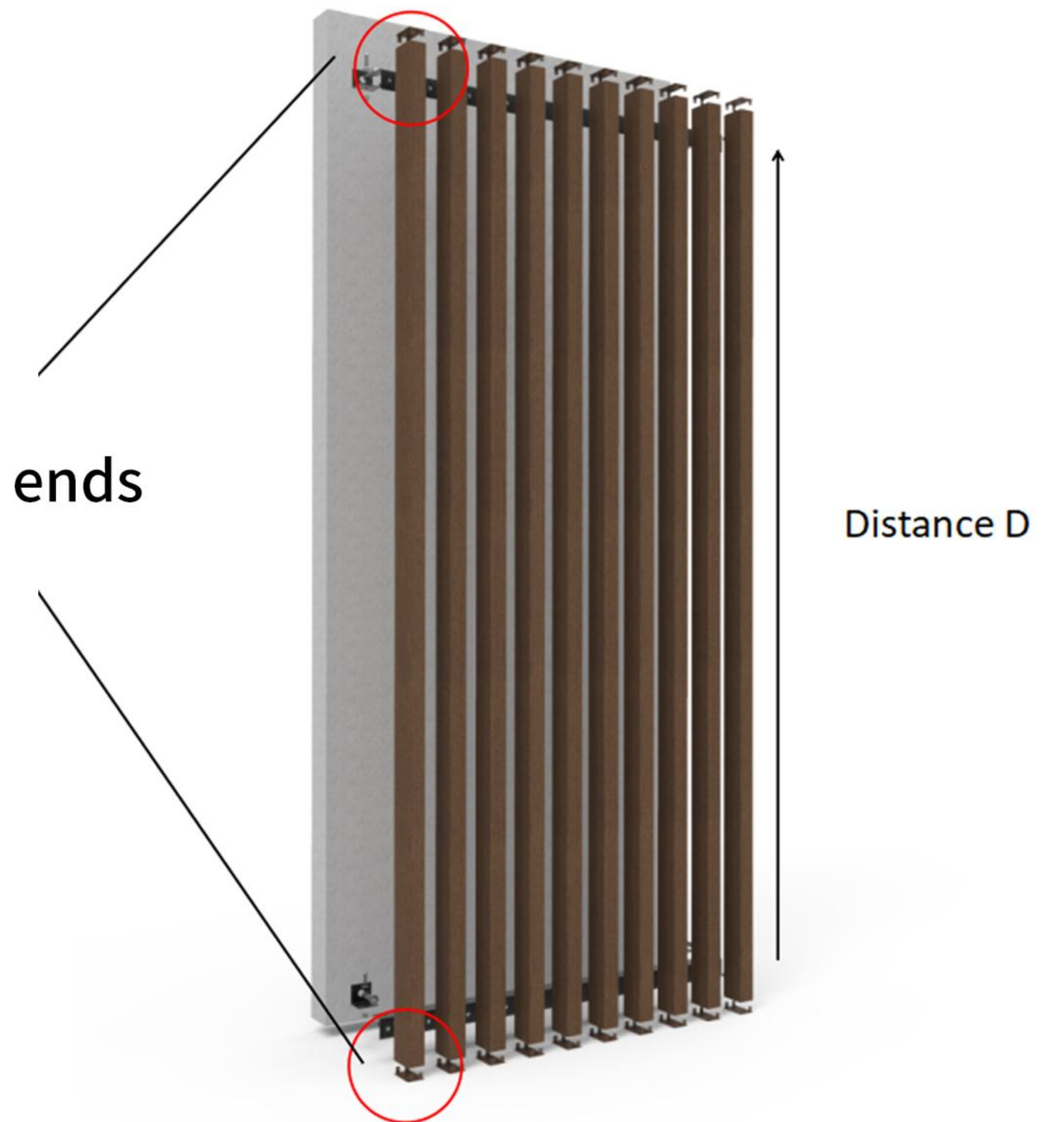

Distance D of L-shape joist

## Step 2: Confirm following based on beam size

- b. L bracket distance
- c. L-shape joist distance
- d. The max hanging length at the two ends



Cap into ends of tube

Step 3: Insert the cap into both ends of the tube

# INSTALLATION EXAMPLE- TUBE VERTICAL INSTALLATION

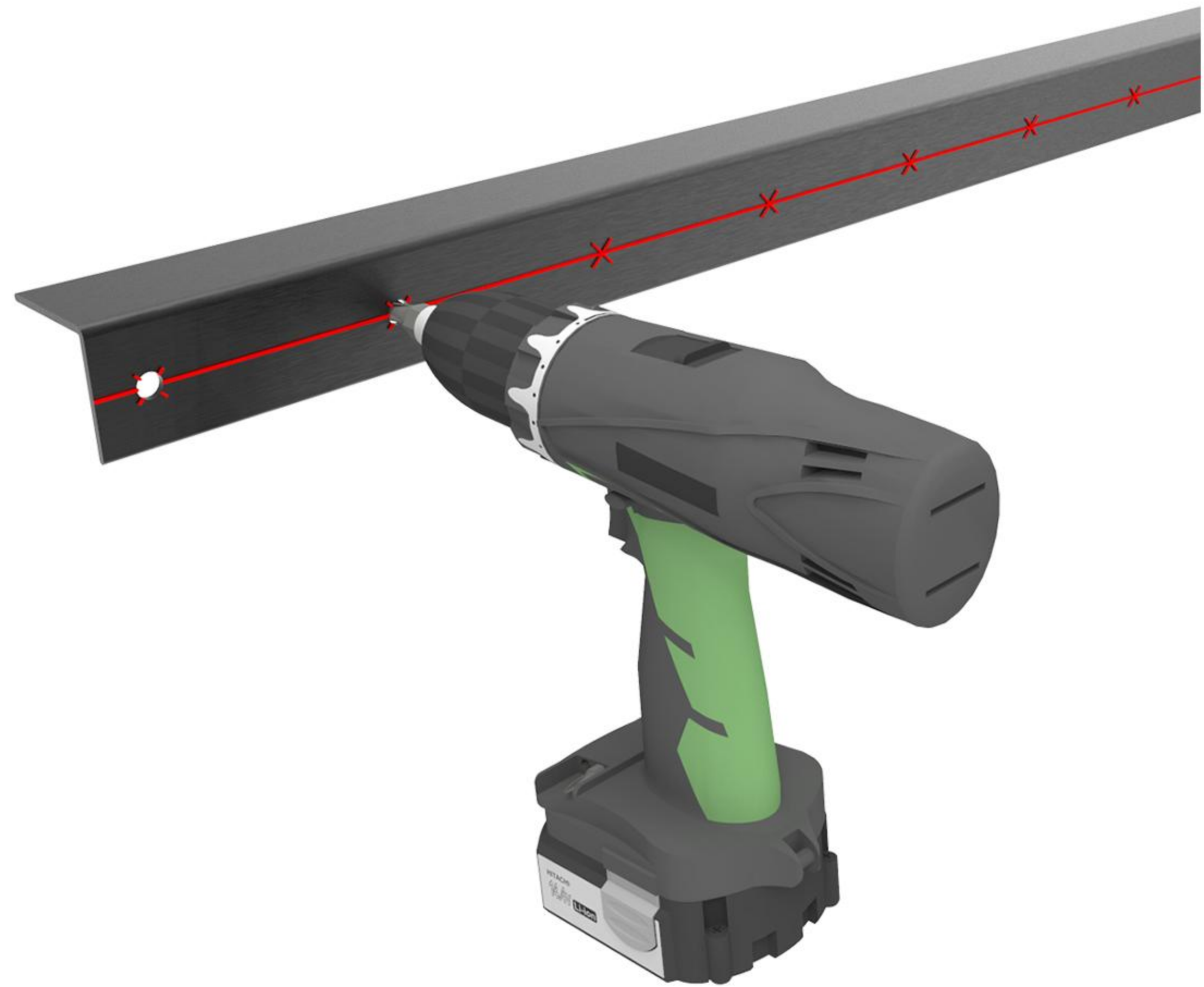

Pre-drill hole on the joist  
(Use level instrument for leveling)



Pre-drill hole at the back of tube  
(Use level instrument for leveling)

## Step 4: Assemble the tube and joist

- a. Put the joist against the back of tube and align them based on the tube distance. After alignment, mark the position on the joist and tube, and then pre-drill the hole from the mark.  
(Use level ruler or other instrument to help with leveling)



# INSTALLATION EXAMPLE- TUBE VERTICAL INSTALLATION



① Put the rivet bolt into the hole



③ After fastening,  
the rivet bolt is fixed on the tube firmly

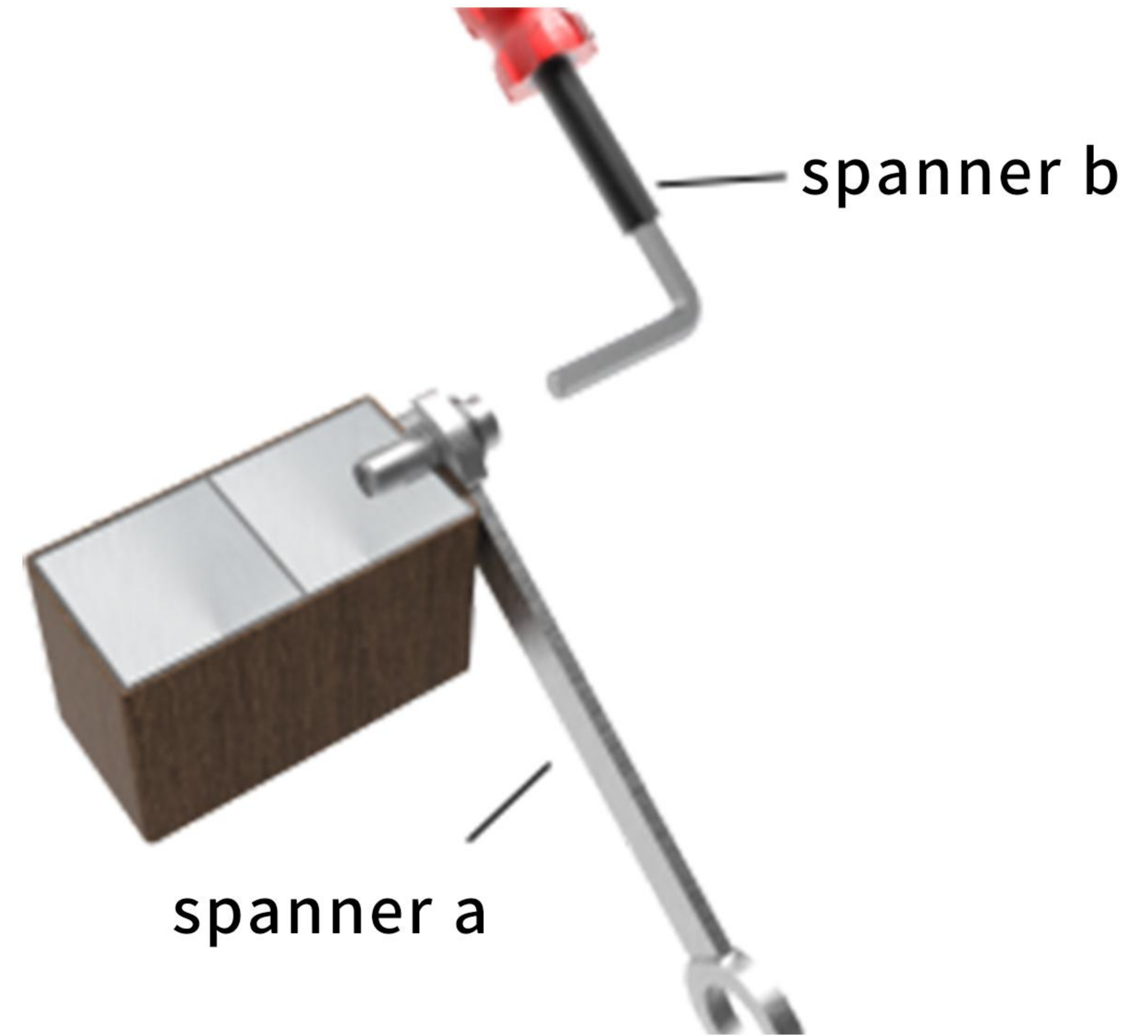
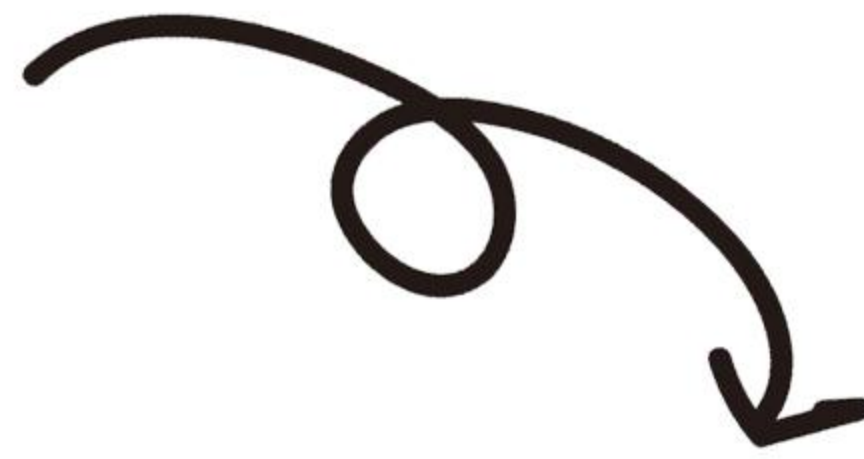

② Put the rivet head in to the bolt.  
While using spanner a to fix the head,  
use the spanner b to fasten the head and bolt



## Step 4: Assemble the tube and joist

b. Mount the rivet bolt at the back of tube



Align the screw to the hole on joist  
and the rivet bolt and fix



After assembling

## Step 4: Assemble the tube and joist

c. Screwing to the rivet to connect the joist and tube.

## INSTALLATION EXAMPLE- TUBE VERTICAL INSTALLATION



Drill on the wall,  
and use expansion screw  
to fix the L bracket on the wall



Installation Schematic

### Step 4: Install the assembled tube frame to the wall

a. Mount the L bracket on the wall

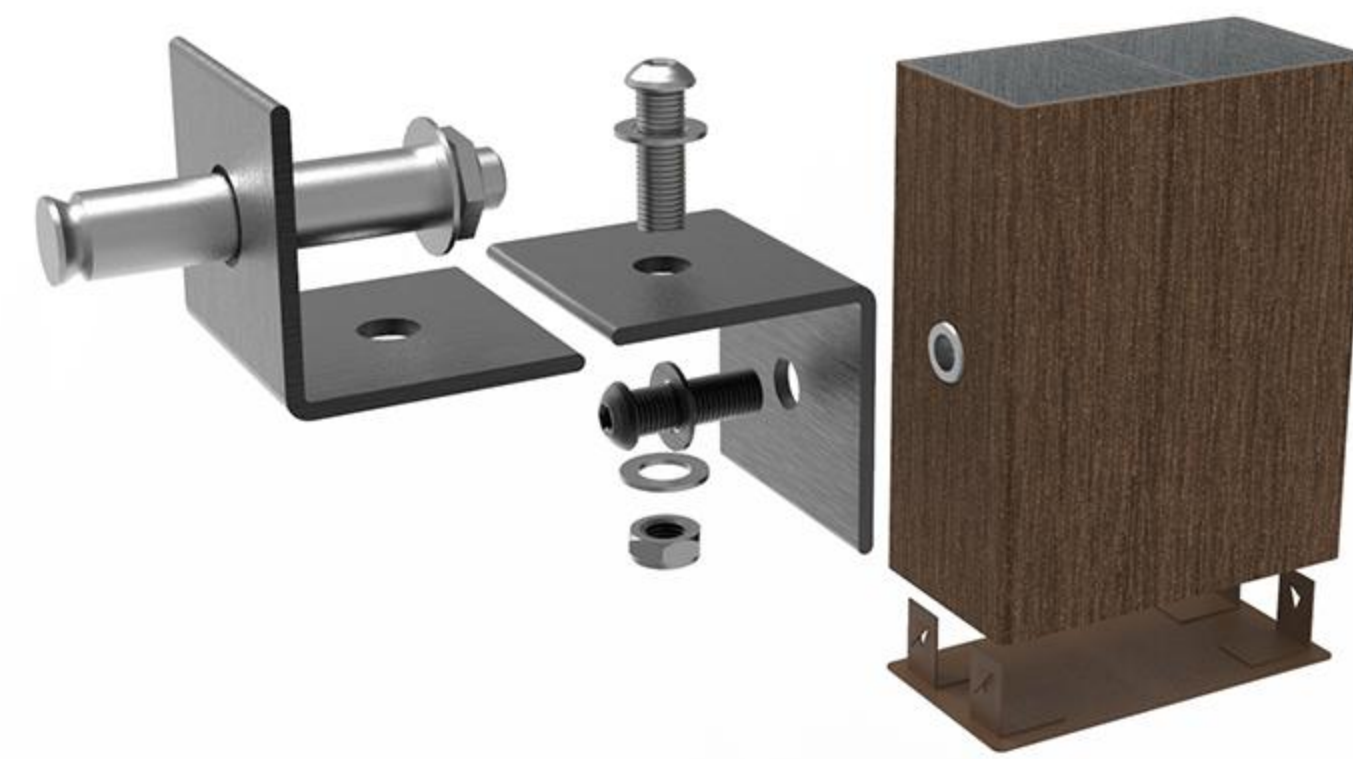

Fix the joist(frame)  
to the bracket



After assembling

## Step 4: Install the assembled tube frame to the wall

b. Fix the frame to the L bracket

## INSTALLATION STEPS



Step 5: Installation finish